

ROSE

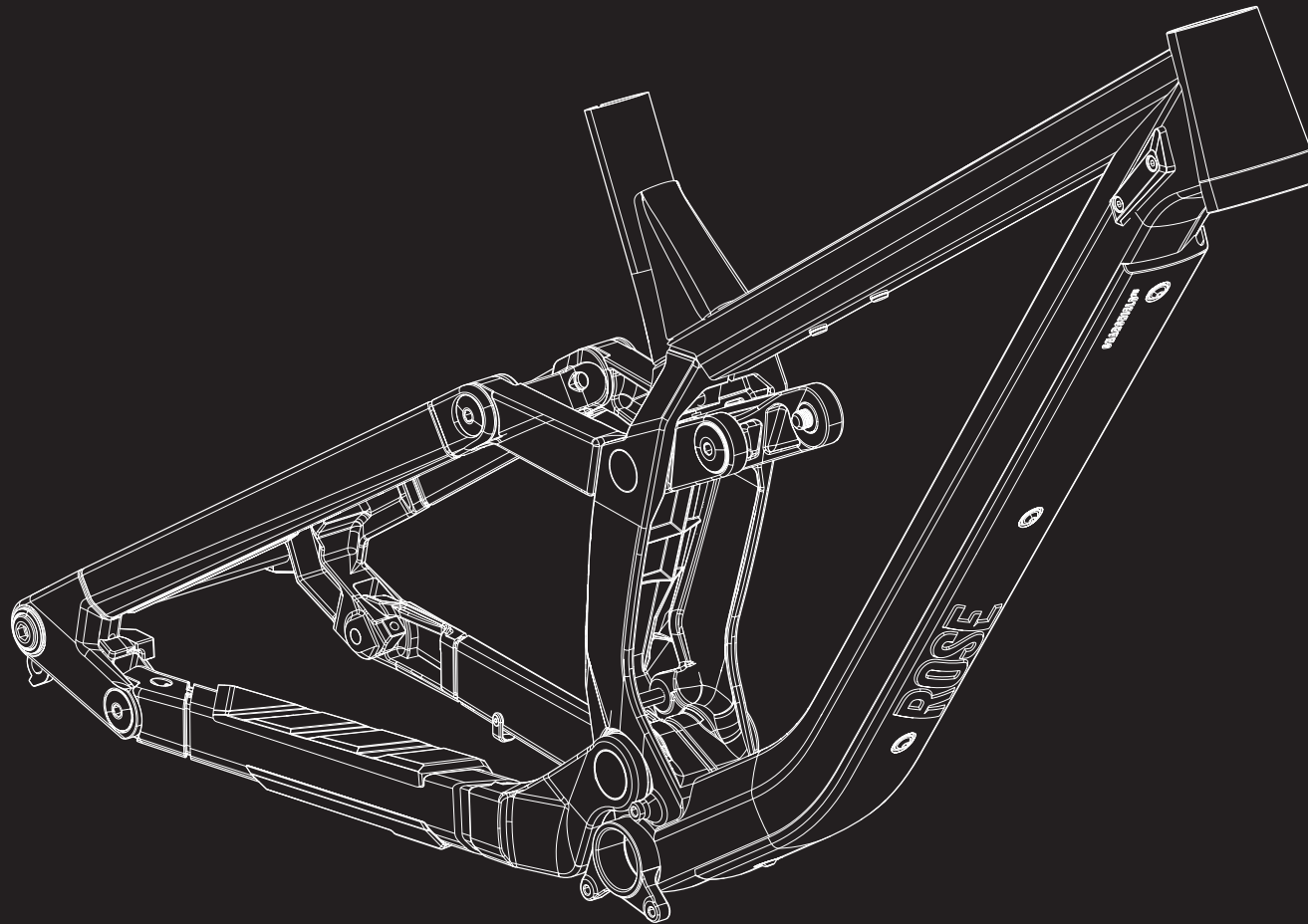

ANY QUESTIONS?
technik@rosebikes.com

ROSE Bikes GmbH
Schersweide 4
46395 Bocholt, Germany

S C R U B

FRAME DETAILS

SCRUB

FRAME DETAILS

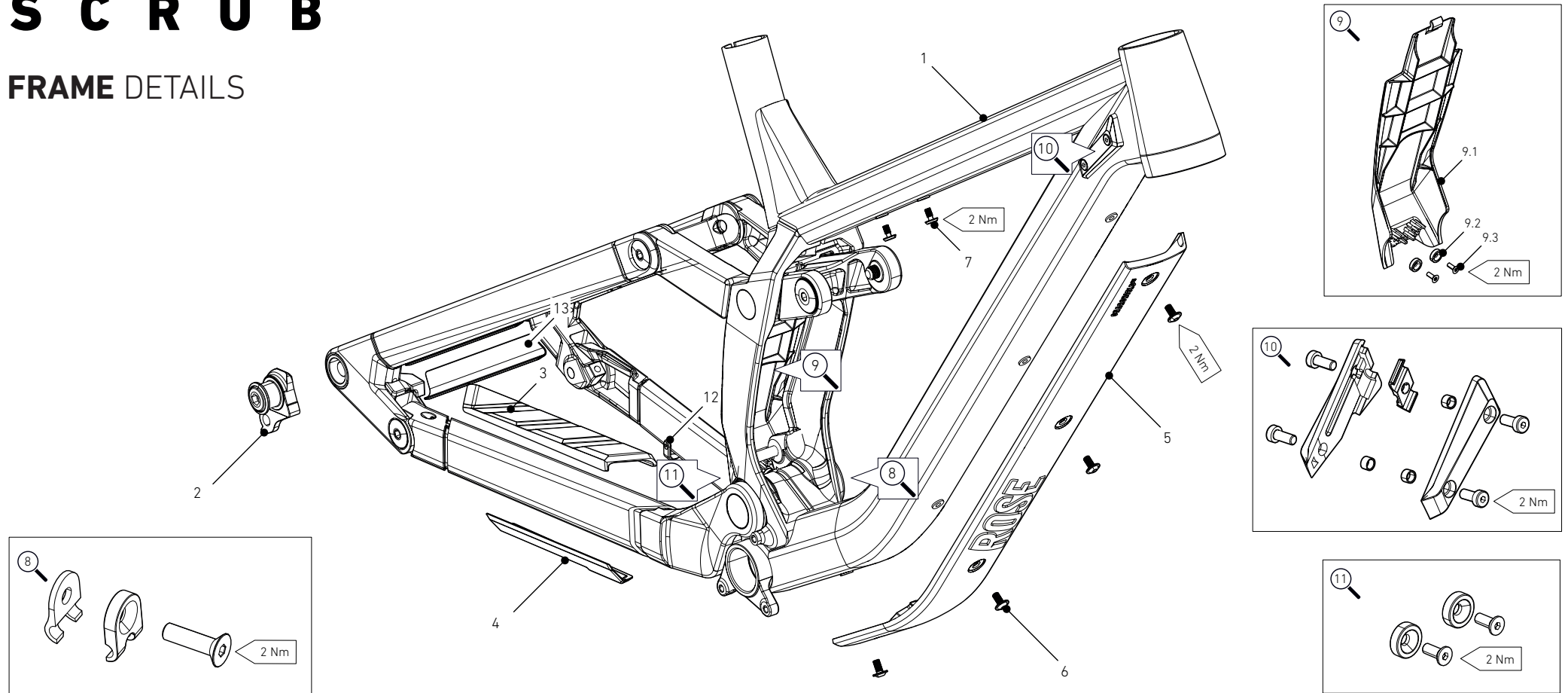

MAIN FRAME DETAILS

POS.	DESCRIPTION	SPECIFICATIONS	ART. NR.
1	frame	color: diet	service only
		color: vanilla	service only
		color: cherry	service only
2	derailleur hanger	UDH	229953201
3	chainstay protection top		233365901
4	chainstay protection bottom		
5	downtube protector		23366801
6	screw	M5x10 for downtube protector	2343390
7	dummy plug		234364701
8	cable clamp		232805201

9.1	shock cover		232805501
9.2	magnet	neodym magnet D10 M3	232801701
9.3	screw	M3x8	232817801
10.1	fork bumper non drive side		232806201
10.2	fork bumper drive side		232806801
10.3	cable clamp fork bumper non drive side		234339401
10.4	screw fork bumper	M5x12	232806701/232807001
10.5	spacer fork bumper		232806301/232806901
11.1	magnet	neodym magnet D10 M3	232802001
11.2	screw	M3x8	232818301
12	brake hose clamp		232805901
13	seat stay protector		230224501

SCRUB

FRAME DETAILS

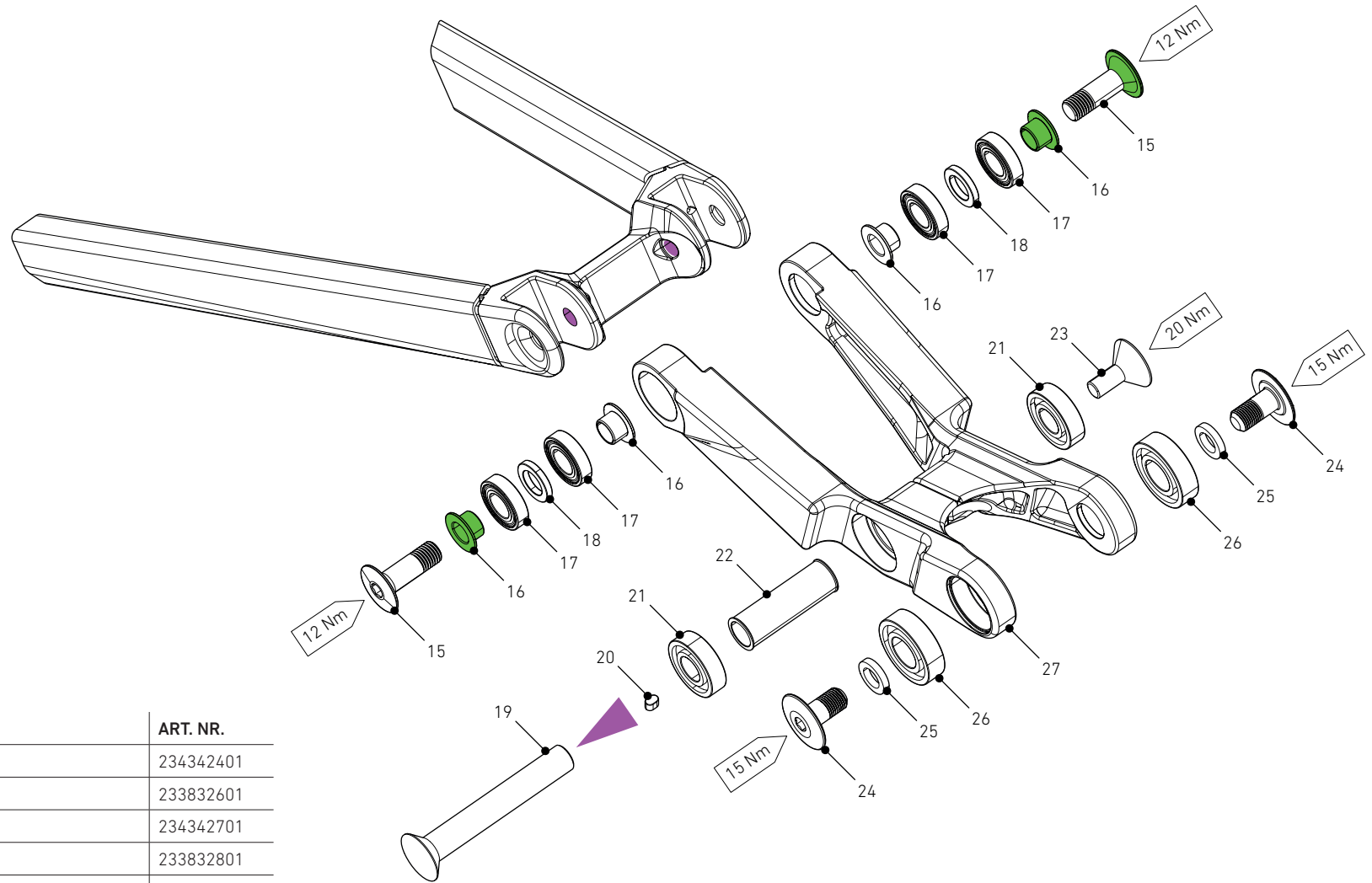

ROCKER DETAILS

POS.	DESCRIPTION	SPECIFICATIONS	ART. NR.
15	pivot screw		234342401
16	spacer rocker		233832601
17	bearing	61901 2RS	234342701
18	bearing spacer		233832801
19	rocker bolt		233833401
20	feather key	4x4x6 mm	234339501
21	rocker bearing		233832401
22	rocker sleeve		233832301
23	rocker bearing screw		233833501
24	trunnion screw		233833901
25	trunnion disc		233833701
26	bearing	6000V 2RS	233832501
27	rocker		service only
	GREASE	Motorex Bike Grease 2000 100 g	49208600
	THREADLOCKER	mid strength, for example Art. Nr. 1322431	

SCRUB

FRAME DETAILS

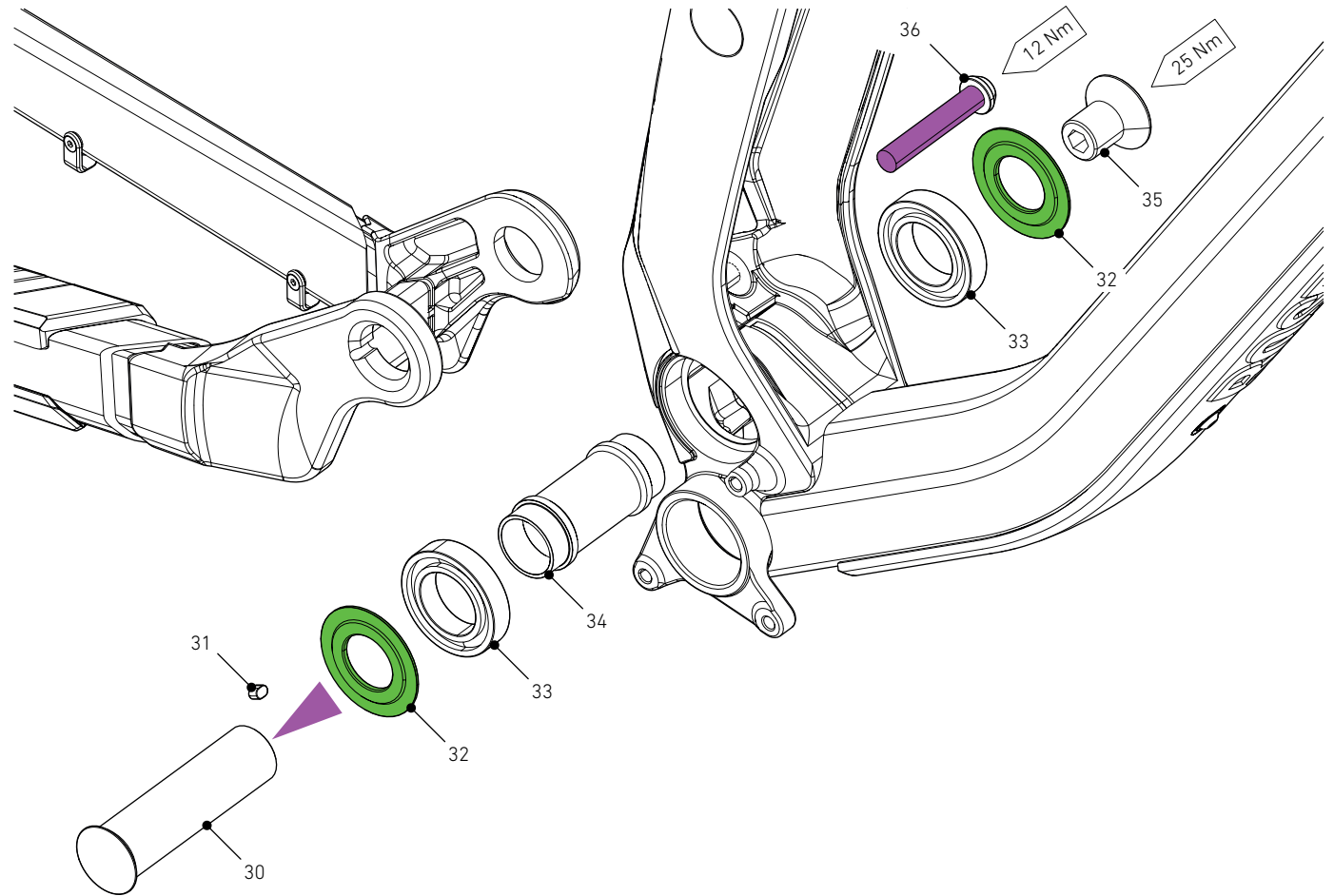

MAIN PIVOT DETAILS

POS.	DESCRIPTION	SPECIFICATIONS	ART. NR.
30	main pivot bolt		233833201
31	feather key	4x4x6 mm	234339501
32	main pivot spacer		233833101
33	main pivot bearing	61905 2RS	233833001
34	main pivot sleeve		233832901
35	main pivot screw		233833301
36	shock screw	M8x45 mm	233834101
	GREASE	Motorex Bike Grease 2000 100 g	49208600
	THREADLOCKER	mid strength, for example Art. Nr. 1322431	

SCRUB

FRAME DETAILS

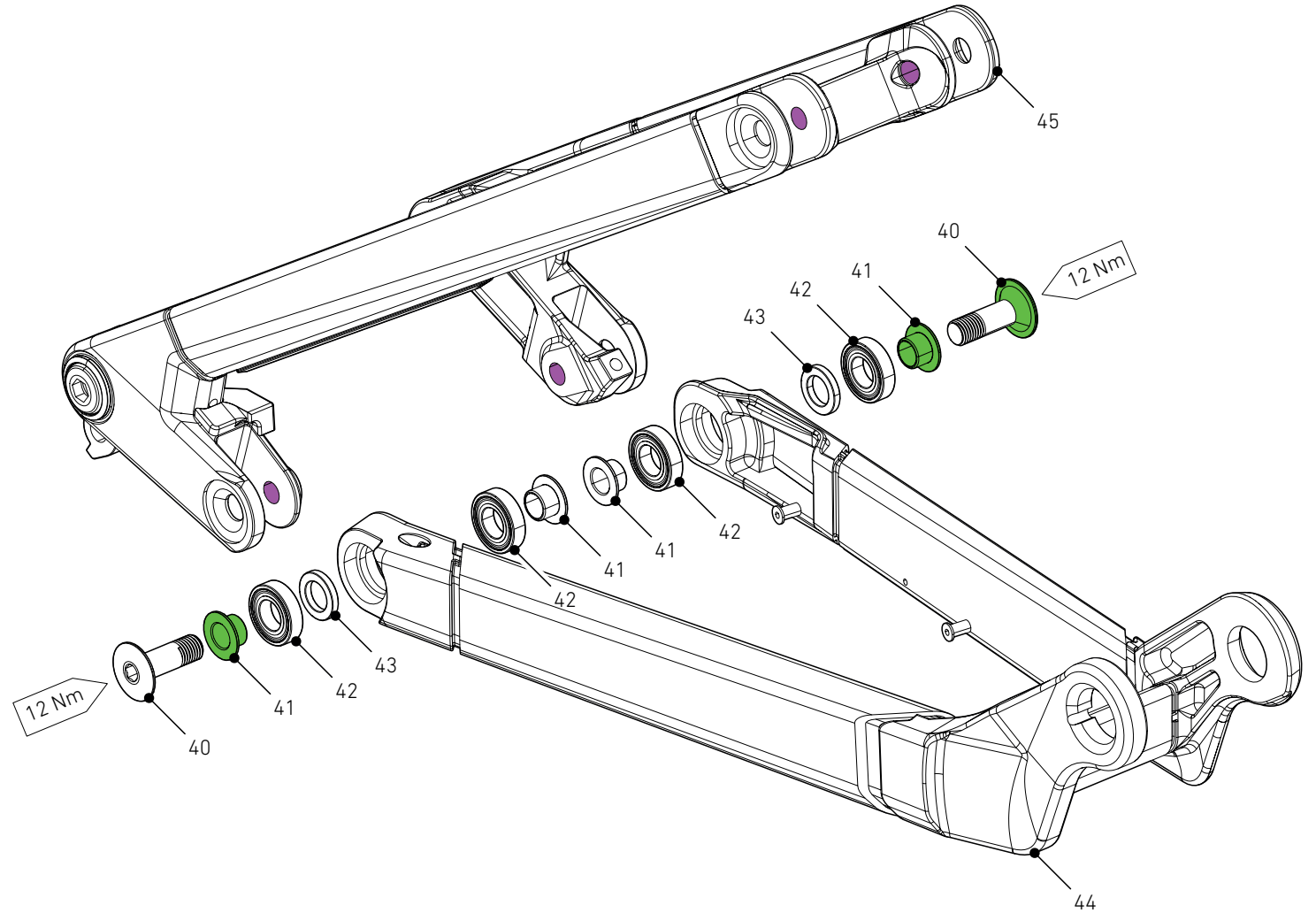

HORST LINK DETAILS

POS.	DESCRIPTION	SPECIFICATIONS	ART. NR.
40	pivot screw		234342401
41	spacer horst link		233832601
42	bearing	61901 2RS	234342701
43	bearing spacer		233832801
44	chain stay unit		234342901
45	seat stay unit		234343001
	GREASE	Motorex Bike Grease 2000 100 g	49208600
	THREADLOCKER	mid strength, for example Art. Nr. 1322431	

SCRUB

FRAME GEOMETRY

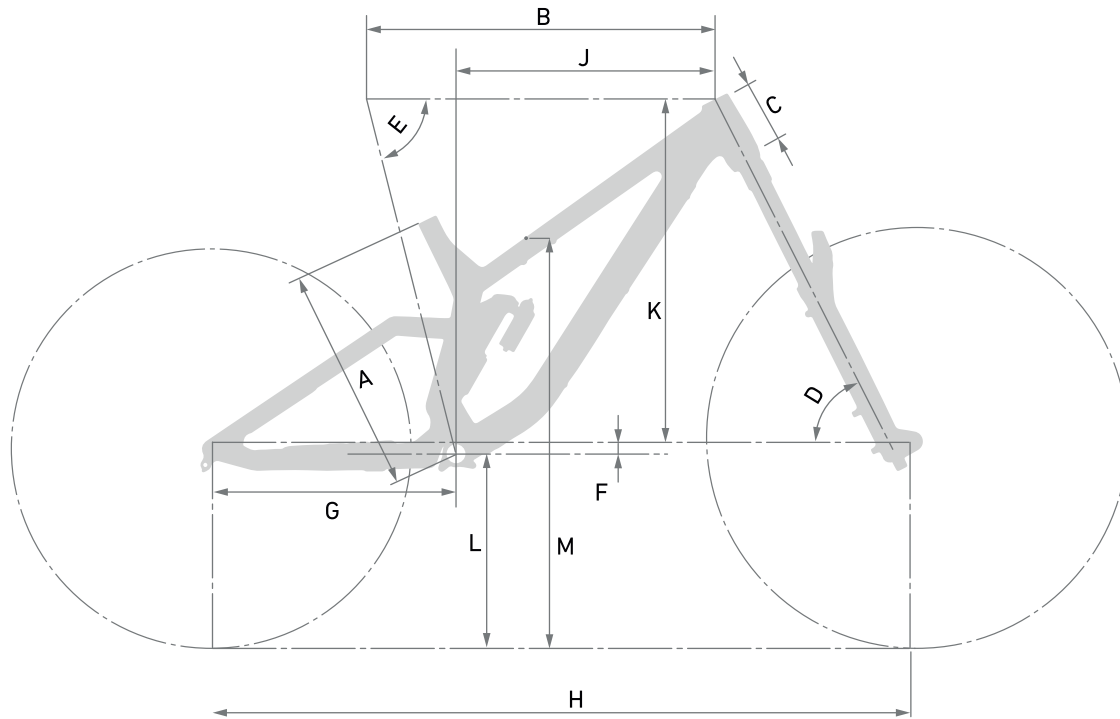

		SIZE S	SIZE M	SIZE L	SIZE XL
SEAT TUBE LENGTH	A	420 mm	420 mm	430 mm	440 mm
TOP TUBE LENGTH	B	595 mm	620 mm	647 mm	669 mm
HEAD TUBE LENGTH	C	100 mm		110 mm	
HEAD ANGLE	D	63° / 64°			
SEAT ANGLE	E	76°			
BB DROP	F	-2 mm			
CHAIN STAY LENGTH	G	435 mm		445 mm	
WHEEL BASE	H	1233 mm	1258 mm	1296 mm	1318 mm
REACH	K	435 mm	460 mm	483 mm	505 mm
STACK	L	630 mm		640 mm	
BB HEIGHT	M	348 mm			
STANDOVER HEIGHT	N	719 mm	716 mm	715 mm	713 mm
TRAVEL FRONT		180 mm - 200 mm			

FRAME INTERFACES

BOTTOM BRACKET	BSA 83 mm
HEADSET	ZS 56 / 56
REAR WHEEL AXLE	188 x 12 x 1 mm thread length: 13 mm
SHOCK LENGTH X STROKE	225 x 70/75 mm
SHOCK HARDWARE	30x8 mm
REAR BRAKE MOUNT	PM180
MAX. Ø REAR BRAKE DISC	220 mm
Ø SEAT TUBE	31.6 mm
Ø SEAT POST CLAMP	36 mm, e.g. ROSE seat post clamp, Art. Nr. 226113801
MAX. TIRE WIDTH	2.4"
WHEEL SIZE	29 front, 27.5" rear
MAX. CHAINRING SIZE	36 T
ISCG	ISCG 05
REAR HUB SPACING	157 x 12 mm DH

MAX SYSTEM WEIGHT (RIDER + BICYCLE + CLOTHING + GEAR + LUGGAGE): 130 KG